



OPC Redundancy and Data Concentration

Using the OPC DA Driver Agent

TABLE OF CONTENTS

Introduction to the OPC DA Driver Agent	3
Why would I want a server to get data from another server?	4
What Cyberlogic products include the OPC DA Driver Agent?.....	4
Solutions to Typical Problems	5
I need an OPC data concentrator!.....	5
I need redundant OPC servers!.....	6
My OPC client and server have different spec levels!.....	7
How do I configure the OPC DA Driver Agent?	9
Windows Security Concerns.....	9
Firewall Exceptions.....	10
Cyberlogic OPC Users	11
Configuring the Network Connections Branch	12
Configuring the Address Space Branch.....	17
Creating the OPC DA Server Device	18
Creating Data Items Manually	19
Creating Data Items by DirectImport	22
Where can I get more information?	25

Copyright © 2009, Cyberlogic® Technologies Inc. All rights reserved.

This document and its contents are protected by all applicable copyright, trademark and patent laws and international treaties. No part of this document may be copied, reproduced, stored in a retrieval system or transmitted by any means, electronic, mechanical, photocopying, recording or otherwise, without the express written permission of Cyberlogic Technologies Inc. This document is subject to change without notice, and does not necessarily reflect all aspects of the mentioned products or services, their performance or applications. Cyberlogic Technologies Inc. is not responsible for any errors or omissions in this presentation. Cyberlogic Technologies Inc. makes no express or implied warranties or representations with respect to the contents of this document. No copyright, trademark or patent liability or other liability for any damages is assumed by Cyberlogic Technologies Inc. with respect to the use of the information contained herein by any other party.

Cyberlogic®, DHX®, MBX®, WinConX® and Intelligent • Powerful • Reliable® are registered trademarks and DirectAccess™, OPC Crosslink™ and DevNet™ are trademarks of Cyberlogic Technologies Inc. All other trademarks and registered trademarks belong to their respective owners.

Document last revision date April 24, 2009

INTRODUCTION TO THE OPC DA DRIVER AGENT

The OPC DA Driver Agent is a plug-in module for Cyberlogic's OPC Server that allows the server to communicate to other OPC DA servers. This may be done whether the other OPC servers are on the local system or on another computer on the network, and may also be done regardless of the brand of OPC servers used.

While most OPC servers obtain data from PLCs or other control and instrumentation devices, an OPC server equipped with the OPC DA Driver Agent can obtain data from other OPC DA servers. It can then present this data to OPC clients just as though it were data obtained from a PLC. In this way, the OPC DA Driver Agent allows you to configure the Cyberlogic OPC Server as an OPC data concentrator or to set up redundant OPC servers. And configuring the OPC DA Driver Agent is just as easy as configuring an ordinary OPC server to communicate with a PLC.

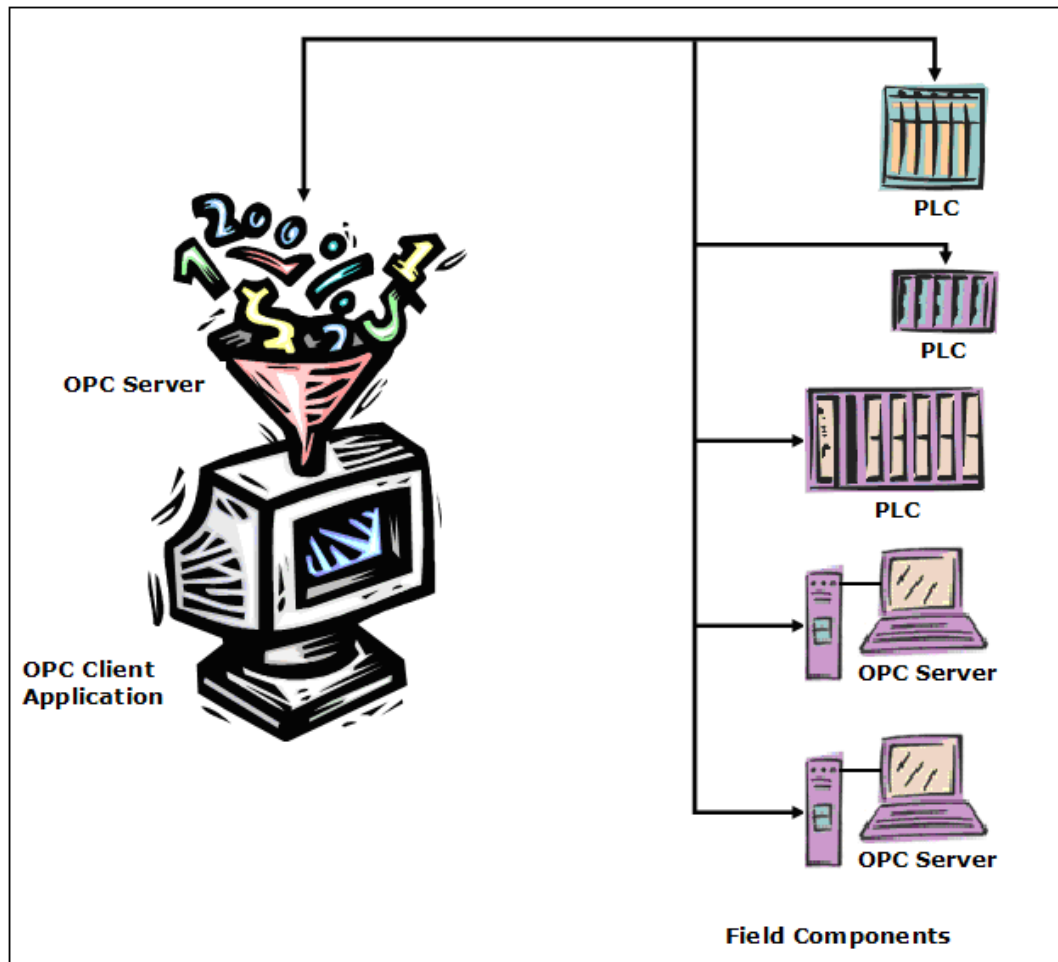

The OPC DA Driver Agent allows your OPC server to communicate to other OPC servers just as easily as it communicates to PLCs

Why would I want a server to get data from another server?

Being able to do so opens up many possibilities, and we will discuss three of them in this paper.

- **Data Concentration:** It may be convenient for you to have a single OPC server that client systems can connect to for all of their information, rather than having them connect to numerous OPC servers scattered around your plant. A single Cyberlogic OPC Server can provide this capability by using the OPC DA Driver Agent to obtain the needed data from all of the other servers.
- **OPC Server Redundancy:** For some installations, data gathering is critical and failure of an OPC server would be very costly or catastrophic. In such a situation, you can set up two or more identical OPC servers to gather data and use an OPC server with the OPC DA Driver Agent to connect to all of them. If any should fail, the remaining servers would still be available to provide data to the clients.
- **Specification Translation:** Suppose you have several older OPC servers that comply only with OPC DA 1.0a, but want to use a newer client application that requires DA 3.0. You could replace all of your old OPC servers, requiring complete reconfigurations and affecting all of the clients throughout your entire plant. Or you could set up a new Cyberlogic OPC Server to get the data from the legacy servers and present it in 3.0-compliant form to the client.

What Cyberlogic products include the OPC DA Driver Agent?

The OPC DA Driver Agent was introduced with version 7 of Cyberlogic's OPC products and is included with:

- OPC Crosslink Suite
- DHX OPC Premier Suite
- MBX OPC Premier Suite

SOLUTIONS TO TYPICAL PROBLEMS

The OPC DA Driver Agent's ability to get data from other OPC servers opens up many useful configuration possibilities. Here, we'll talk about three of them. But you are not limited to just these simple setups. They can be combined to create, for example, a data concentrator that obtains its data from multiple groups of redundant OPC servers.

I need an OPC data concentrator!

Suppose your facility has several OPC servers, perhaps of different brands, gathering data from various areas of your plant. It is possible for the client software to connect to each of these servers to obtain the data it needs.

However, it may simplify the client configuration to instead have a single OPC server get the data from all of the other servers. Now the clients need only to connect to this data concentrator to get all of the information they need.

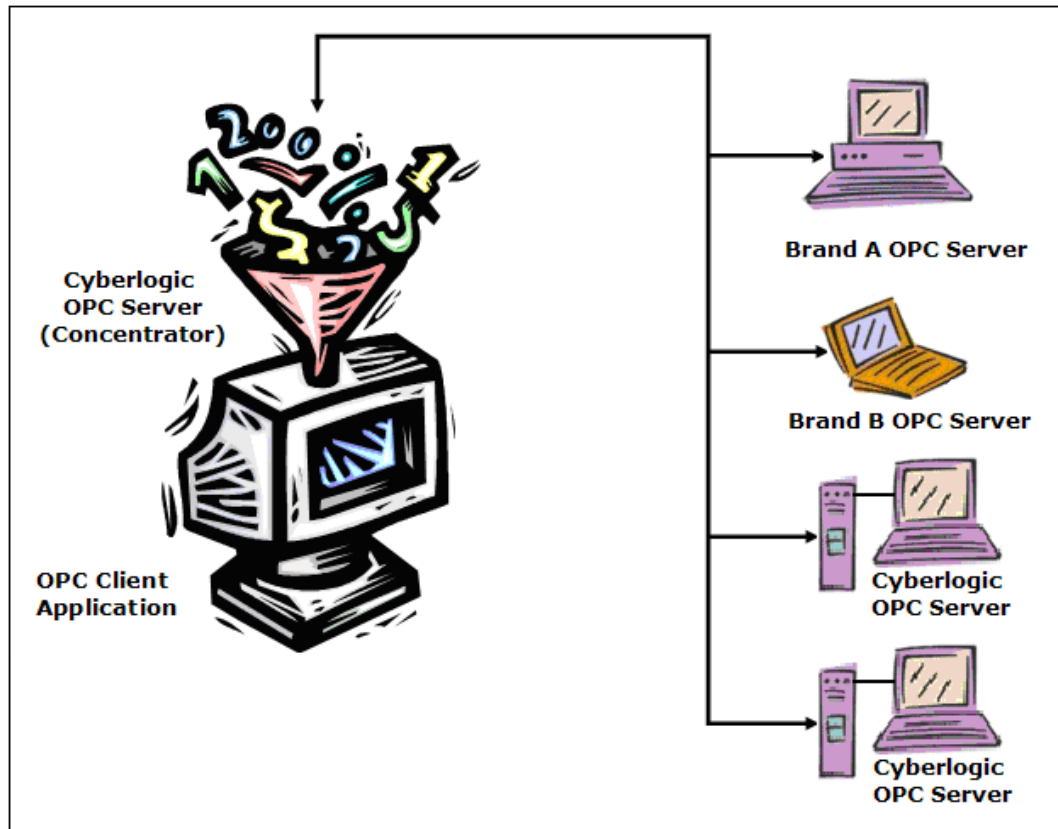

A Cyberlogic OPC Server connects to several other OPC servers, providing a single access point for all of the data.

Such a system will avoid the complications involved in having to connect every client to every server. It allows the data to be organized in an orderly and consistent way in the data concentrator, even if the individual OPC servers are of different brands and were configured by different people at different times. If conversions, range limits or

simulations are needed, they can be applied on a single server, rather than being configured many times on several different servers.

You might also decide to create multiple data concentrators with different user permission levels and accessing different data, to control access to sensitive information.

I need redundant OPC servers!

Critical applications may require you to have a backup OPC server on line and ready to take over if the primary server fails. Cyberlogic's OPC Server provides this capability and, unlike other redundant server products, allows you to configure an unlimited number of backup servers.

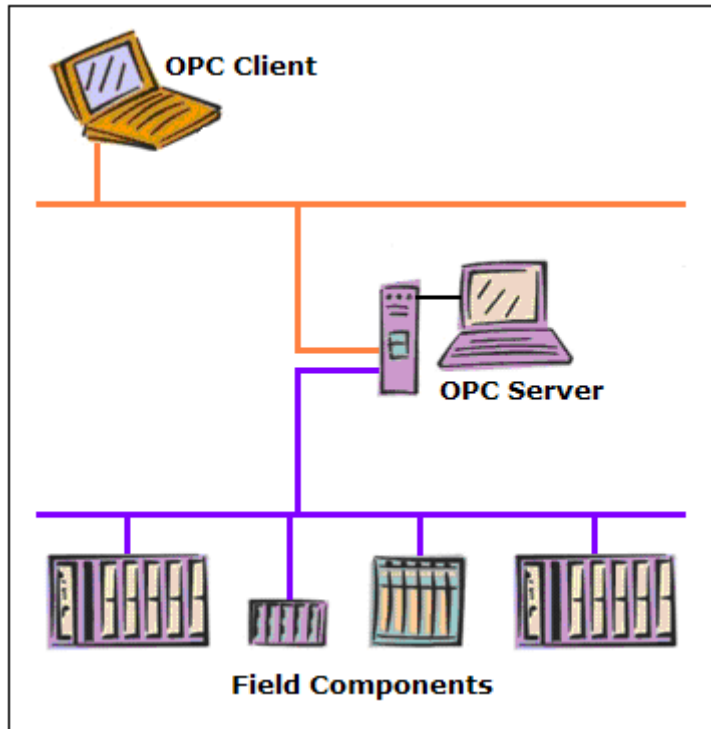

A single OPC server can become a single point of failure

In the configuration shown above, the OPC server is a single point of failure. If that computer fails or is shut down for any reason, the client will lose all access to data until the server is restored to operation.

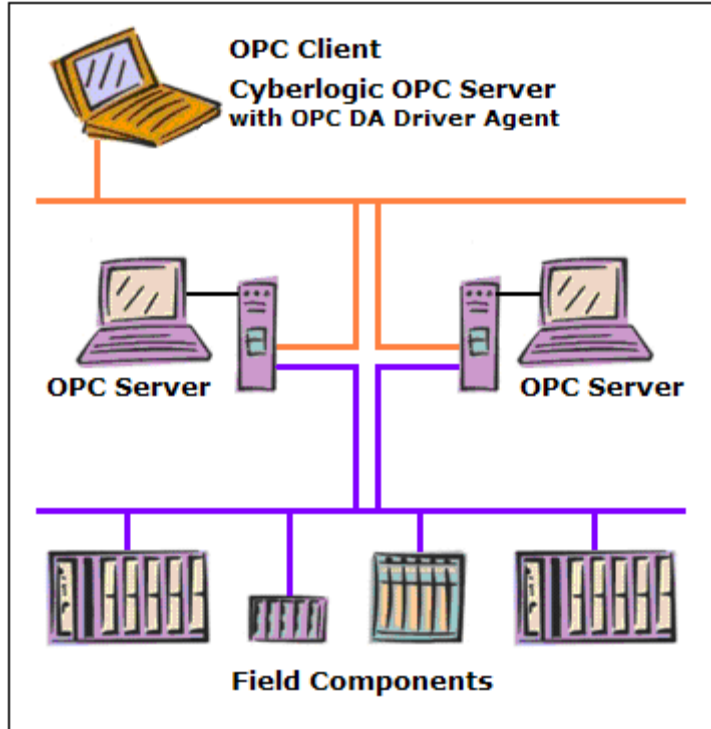

Cyberlogic's OPC DA Driver Agent lets you set up redundant OPC servers for greater reliability

If you install the Cyberlogic OPC Server with the OPC DA Driver Agent on the client system and set up two identical servers, the server on the client system can treat them as a redundant pair. Both servers can be associated with a single device, which will use the primary server to obtain data. If that server should fail, the data access will automatically switch to the other server. When the primary server comes back up, the data access will automatically switch back to it.

You are not restricted to just two servers. Cyberlogic's OPC Server allows you to associate an unlimited number of servers with a single device, so you can have two, three, four or more backup servers.

My OPC client and server have different spec levels!

Suppose your client software requires OPC DA 3.0, but it needs to obtain data from legacy OPC servers that are compliant only to DA 2.05a or even 1.0a. Normally, this couldn't be done, but the OPC data concentrator setup allows it to happen.

What makes it possible is the fact that Cyberlogic's OPC Server complies with all three major OPC DA spec level revisions: 3.0, 2.05a and 1.0a. Because of this, a Cyberlogic OPC Server with the OPC DA Driver Agent can obtain data from a DA 2.05a or 1.0a compliant server and can then provide that data to a DA 3.0 compliant client. By passing the data through the Cyberlogic OPC Server, you can effectively upgrade the compliance level of your other OPC software.

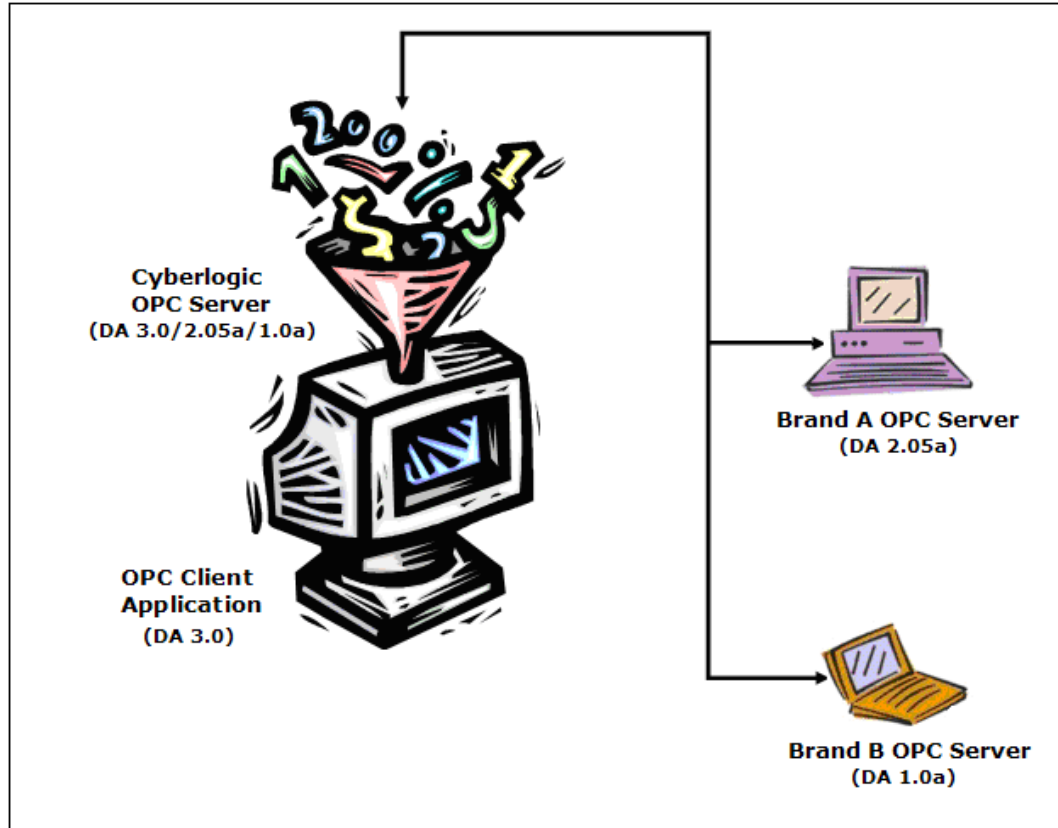

The Cyberlogic OPC Server's multiple compliance levels allow it to solve spec mismatch problems.

Of course, this works the other way as well, allowing you to use an old DA 1.0a client with more recent servers. And because the Cyberlogic OPC Server supports all of the spec levels simultaneously, you can have any combination of mismatched clients and servers, and the data concentrator will do the job for all of them.

HOW DO I CONFIGURE THE OPC DA DRIVER AGENT?

Configuration of the OPC DA Driver Agent is very similar to the configuration of the DHX, MBX and ControlLogix Driver Agents. Full details of the configuration process are available in the OPC DA Driver Agent Help file, but we will provide a brief summary of the process here.

Windows Security Concerns

When configuring an OPC server, it is important to properly configure the Windows operating system security features. This is necessary to permit communication between the OPC servers, especially if they are on different computers. The easiest way to do this is to use the Cyberlogic Control Panel.

This is a brief introduction to the basic concepts of configuring Windows security with the Cyberlogic Control Panel. For more information, refer to the Cyberlogic Control Panel Help.

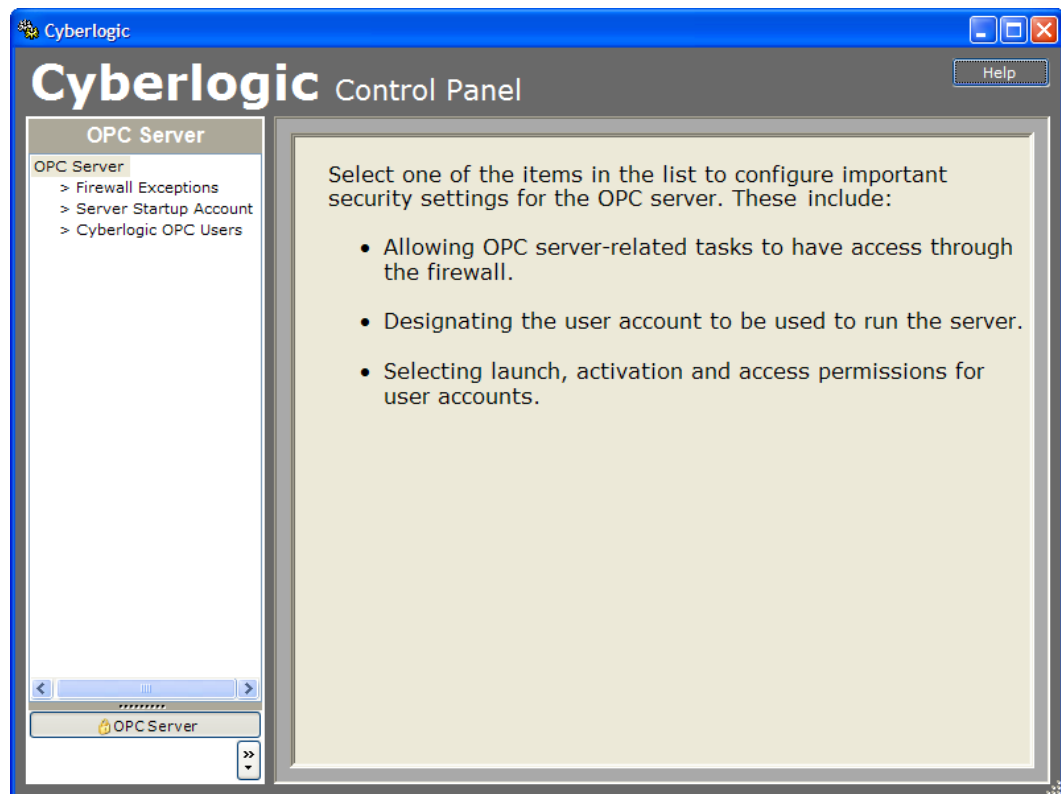

You open the Cyberlogic Control Panel from the Windows Start menu. There are three functions available for configuration. We will look at the firewall exceptions and user accounts.

Firewall Exceptions

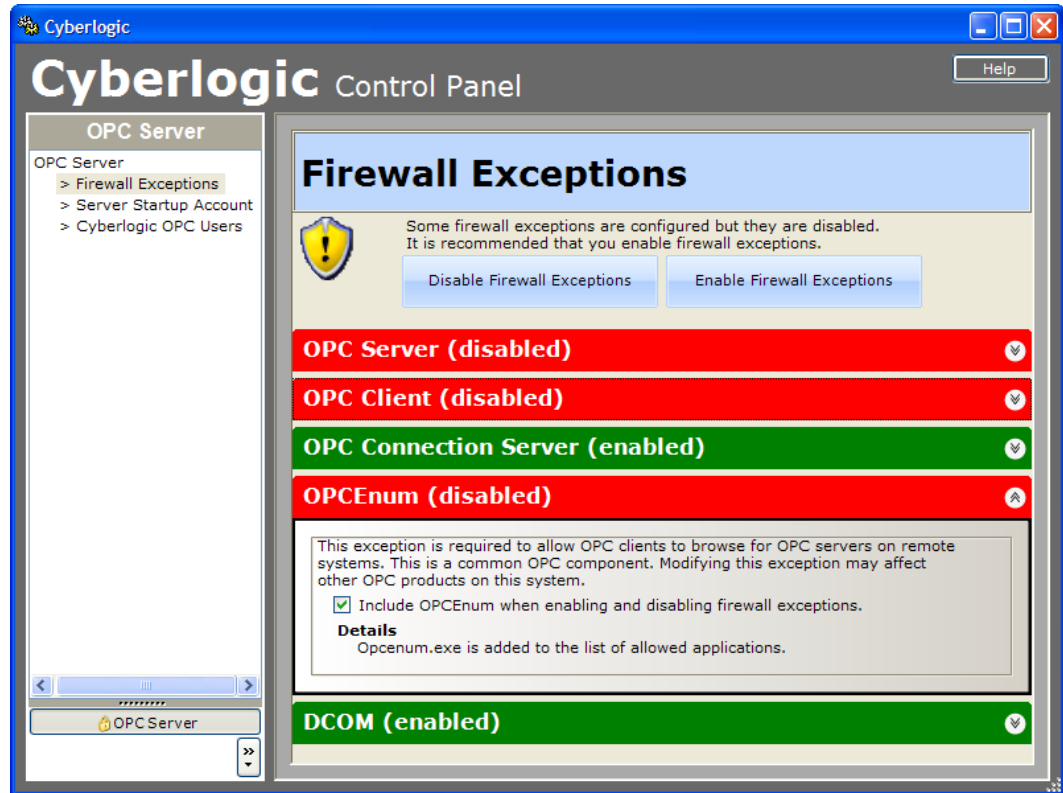

Cyberlogic’s installation software adds various programs and services to the Windows firewall exception list, but does not enable these exceptions. If you have not already enabled them, they will be shown on this screen in red and marked as disabled.

You can click on the double arrow at the right end of each item to get more details on what that exception will do. To allow communications to/from remote computers, all firewall exceptions have to be enabled.

To enable the exceptions, click the **Enable Firewall Exceptions** button.

Note, however, that these exceptions apply only to the Windows firewall. If you have installed a third-party firewall, you must manually configure the same exceptions.

Cyberlogic OPC Users



During the product installation, a users group called Cyberlogic OPC Users is automatically created and added to the security settings for the Cyberlogic OPC Server. By default, only the user that installed the software is added to this group, however, other users can also be added later. Using a group makes it easy and efficient to apply the needed permissions to every user who will need to run the Cyberlogic OPC server software.

Use the Add... and Remove buttons to select the members of the group. Once you have done that, use the check boxes on the right side to set the desired permissions. The list of permissions available for configuration will vary depending on the operating system you are using, but in all cases the recommendation is to allow all permissions that are shown. Note, that allowing all permissions here does not affect the security settings for other applications and is therefore safe to do.

Configuring the Network Connections Branch

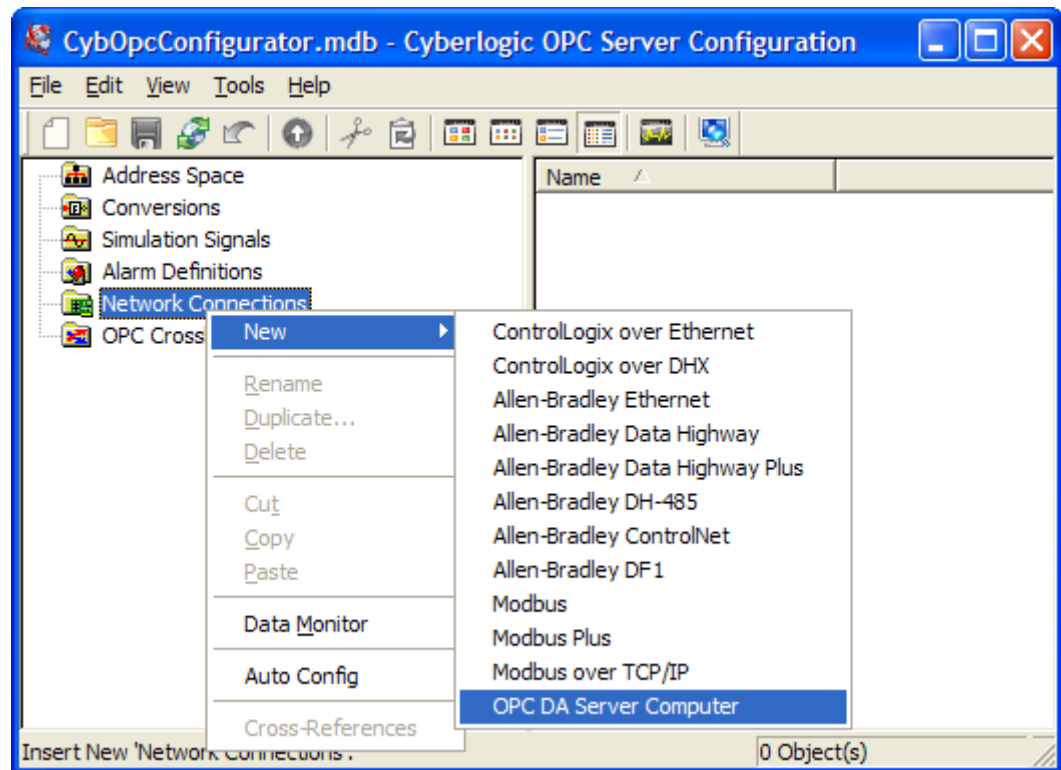

First, you must identify the computer that is running the OPC DA server that you want to use as the source of the data.

This is similar to configuring a network connection.

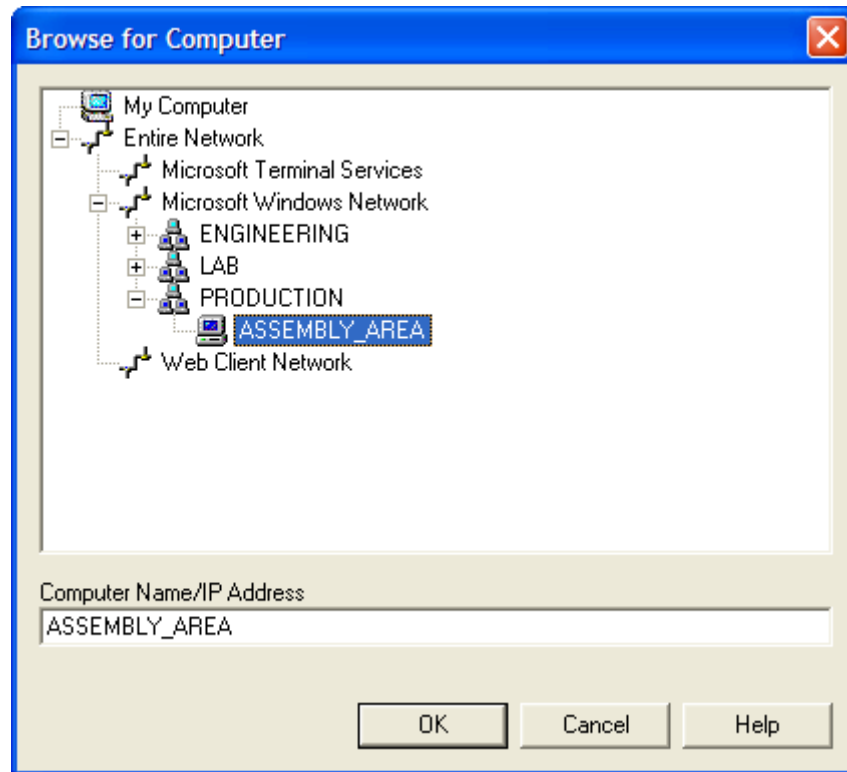

You can enter the name or IP address of the computer, or just browse for it.

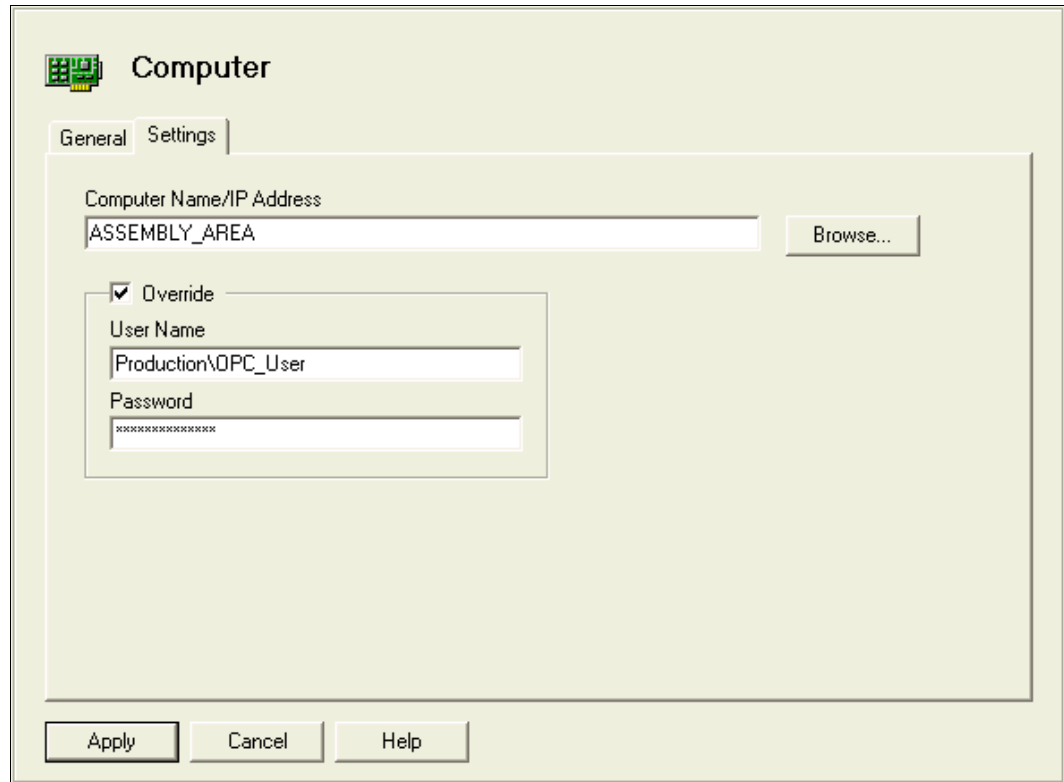

The OPC server will use a default user name and password when connecting to other OPC servers. If you prefer, you can override these defaults and specify a different user name and password for this specific computer. To maintain system security, the user name and password that you enter here are stored in a secure way.

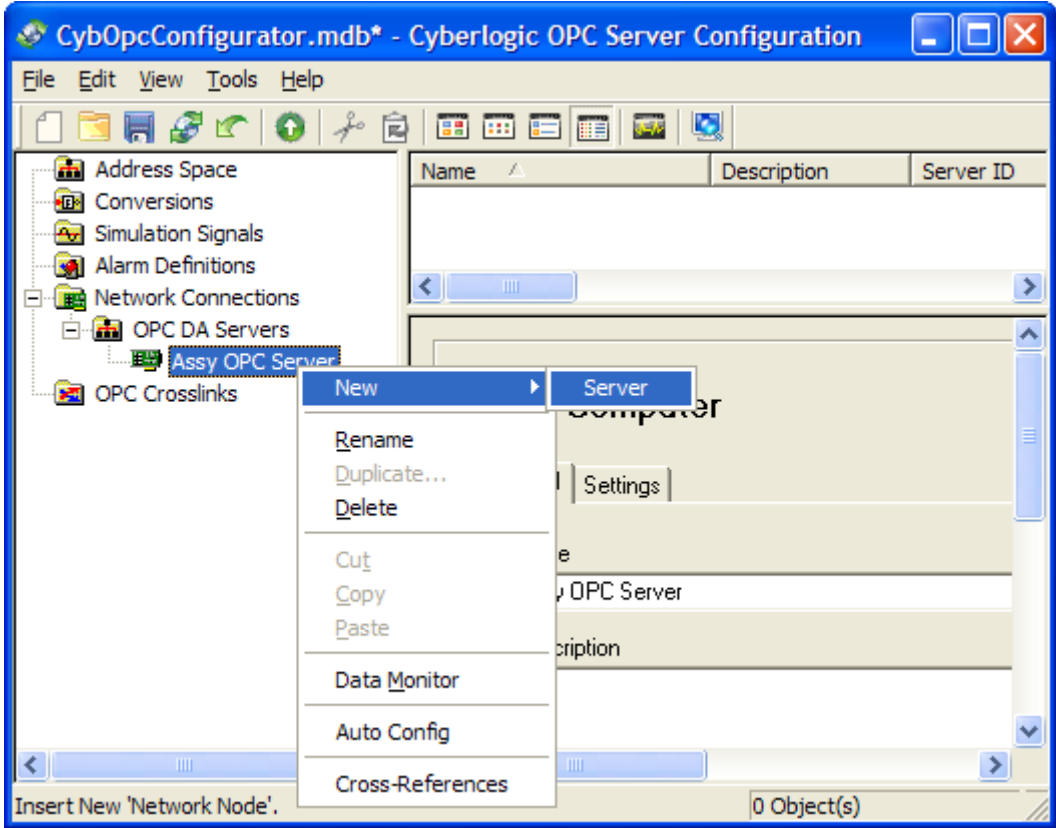

Just as each network connection may have more than one network node, so each OPC DA Server computer may have more than one OPC server. You must now identify the specific server you wish to connect to.

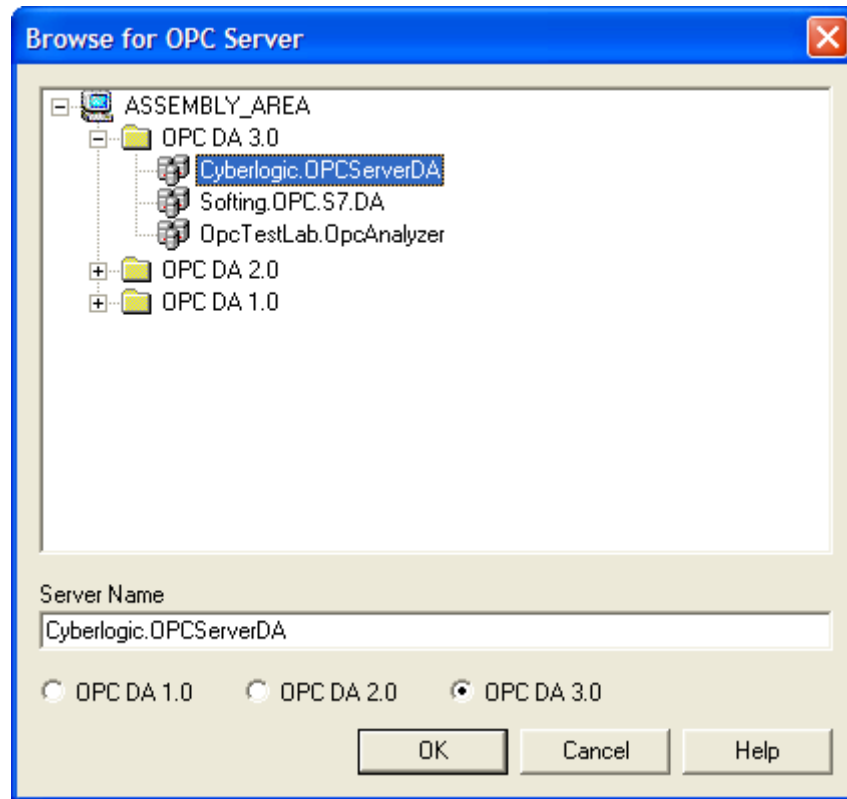

A browse window makes it easy to pick the OPC server and spec level you want to use.

The selection you make will automatically appear in the fields at the bottom of the window.

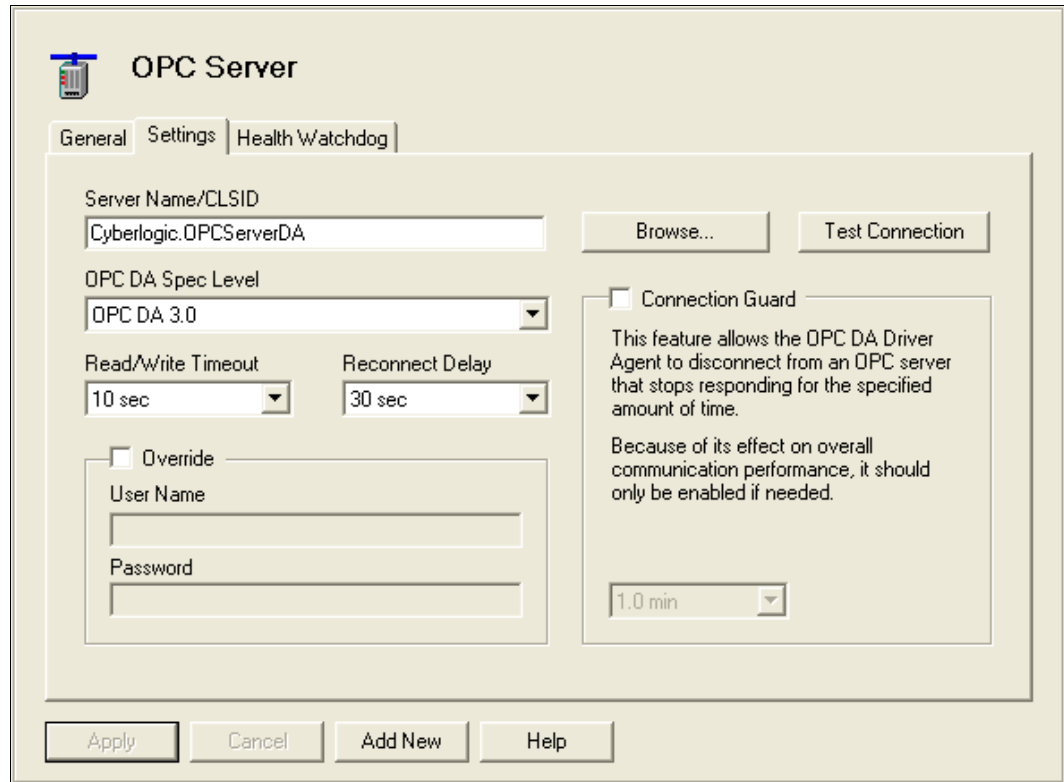

Once again, you can elect to override the default user name and password, if you wish, and you can also set up some additional properties.

Once you've selected the desired settings, click **Apply** and then click **Test Connection**. The driver agent will try to connect to the selected server, and will give you a diagnostic message if the connection cannot be made.

Configuring the Address Space Branch

Configuration of the Address Space for an OPC DA server works just like it does for a PLC in a conventional OPC configuration.

Creating the OPC DA Server Device

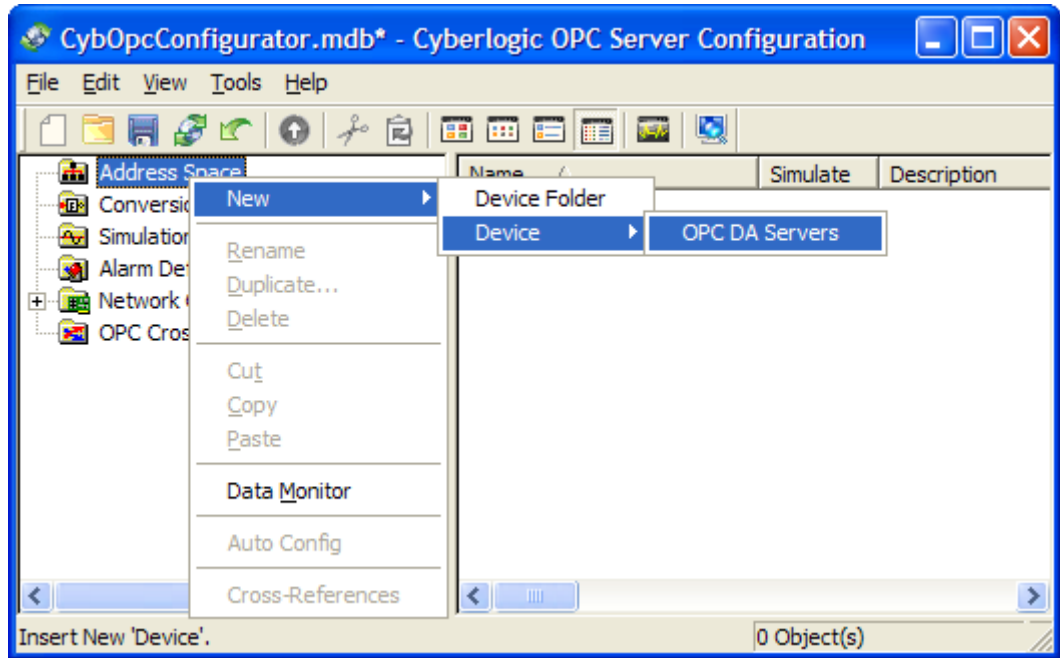

You can create an OPC DA Server device, putting it in a device folder, if you wish.

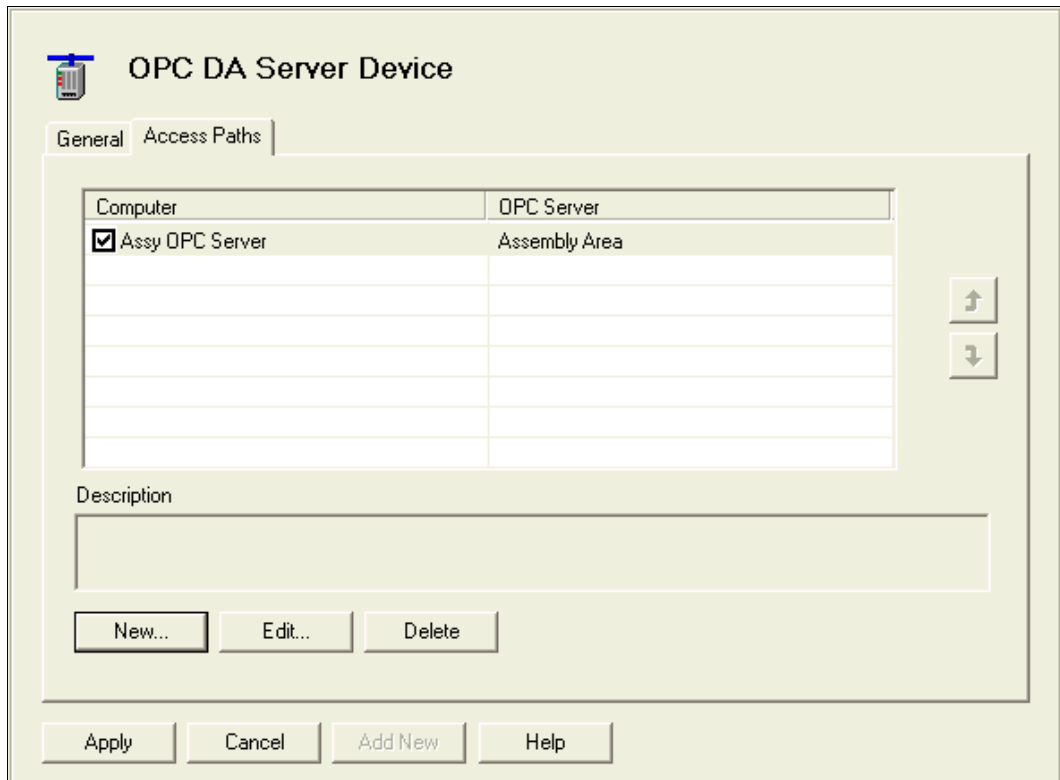

The OPC DA Server Device has access paths, just like any other device. And just like any other device, you can configure two or more access paths for redundancy.

The only difference is that, instead of going to a PLC through a network connection, these access paths go to an OPC server on a computer.

Once you've created the OPC server device, you can configure folders and data items within it. There are two ways to do this: manually or by DirectImport.

Creating Data Items Manually

Manual configuration is typically used when there are only a few data items you wish to configure.

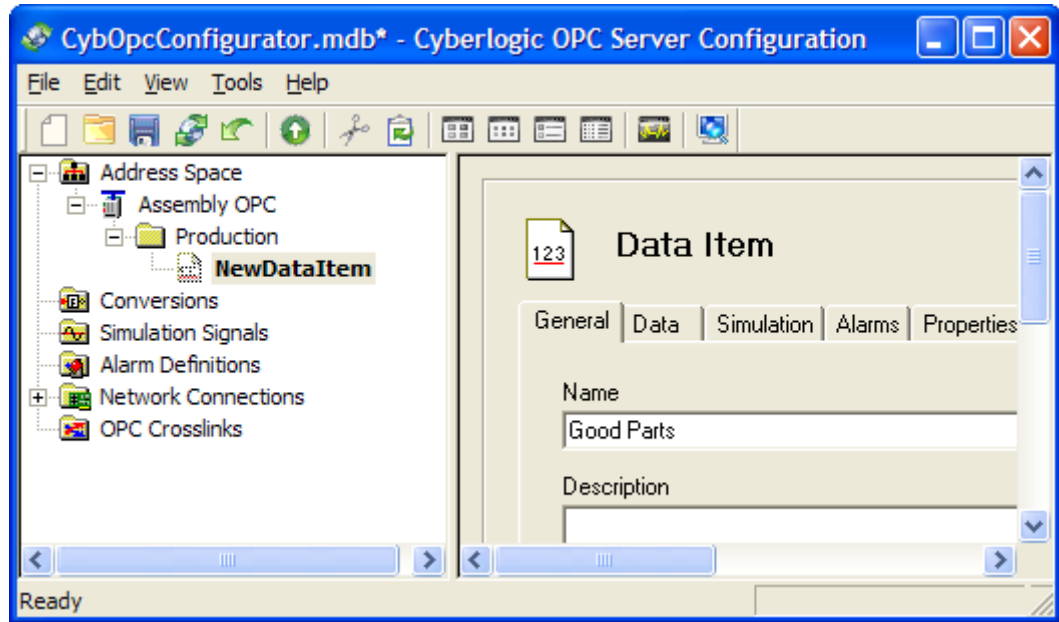

The folders and data items look just like those in a device associated with a PLC. But instead of bits or registers within a PLC, these data items link to data items in the OPC server you are connected to.

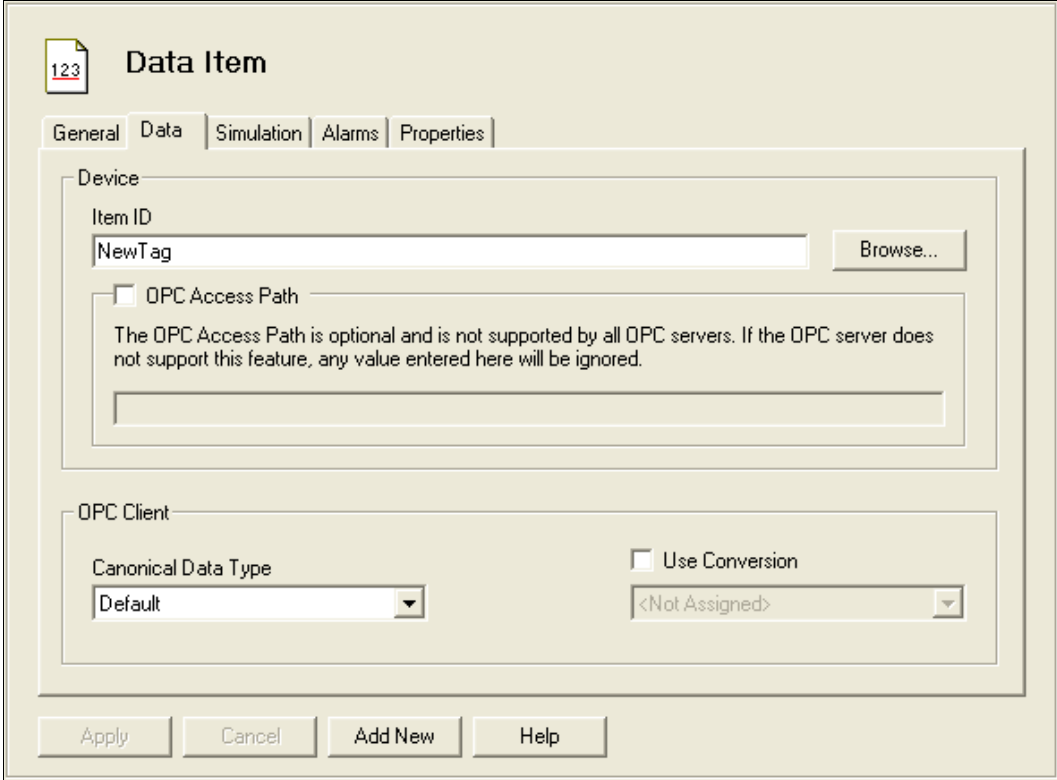

The Data Item editing screens are the same as those for any other data item. The only variation is on the Data tab, where you will enter the Item ID rather than a register address. You can, of course, browse for the Item ID you wish to use.

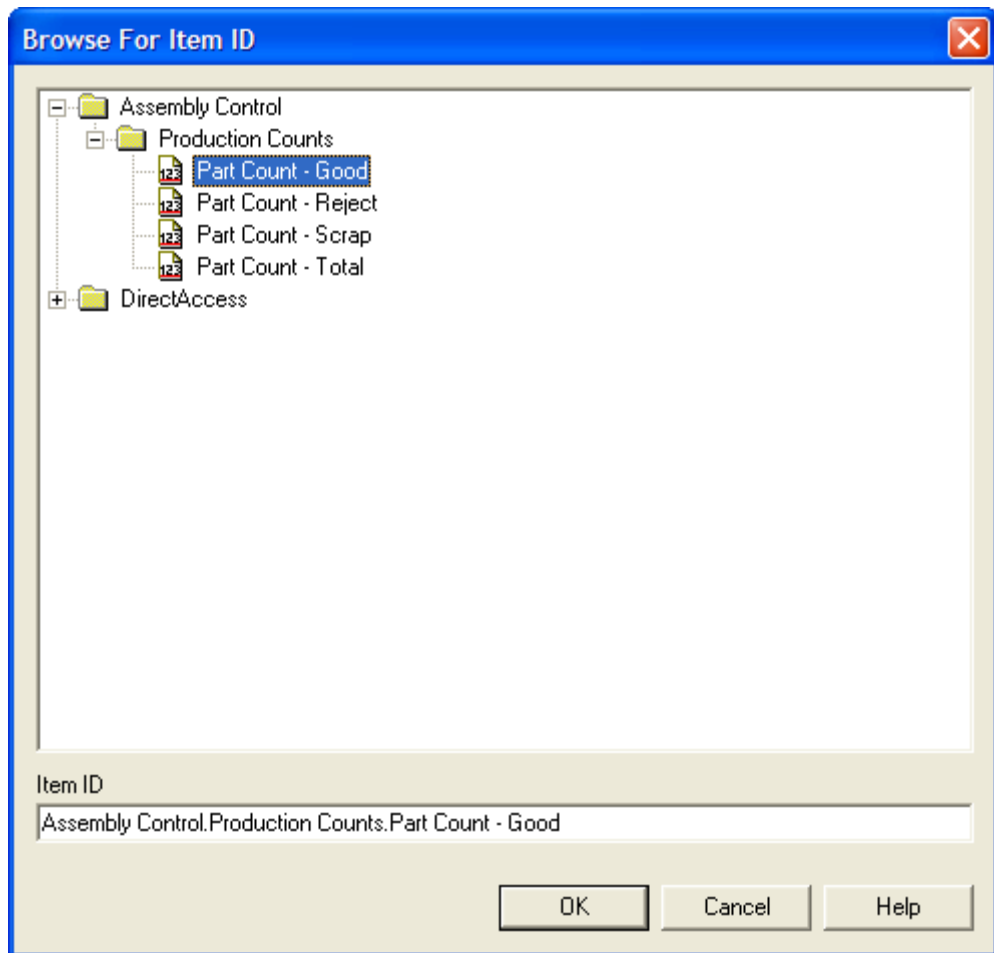

The Browse For Item ID screen makes it easy for you to locate and specify the desired data item.

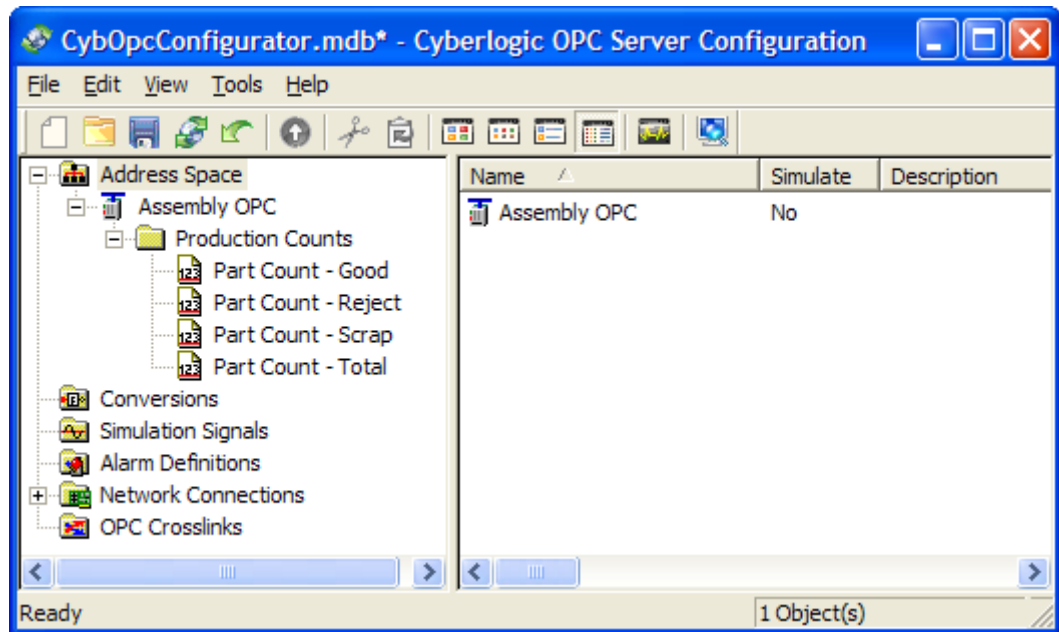

When you are finished, the configuration of the device and its data items will look and work just like those related to PLCs and their registers.

Creating Data Items by DirectImport

If you have a large number of data items to configure, it will be much easier and faster to use DirectImport. This feature presents you with the entire configuration of an OPC DA server and lets you choose to import all or part of it.

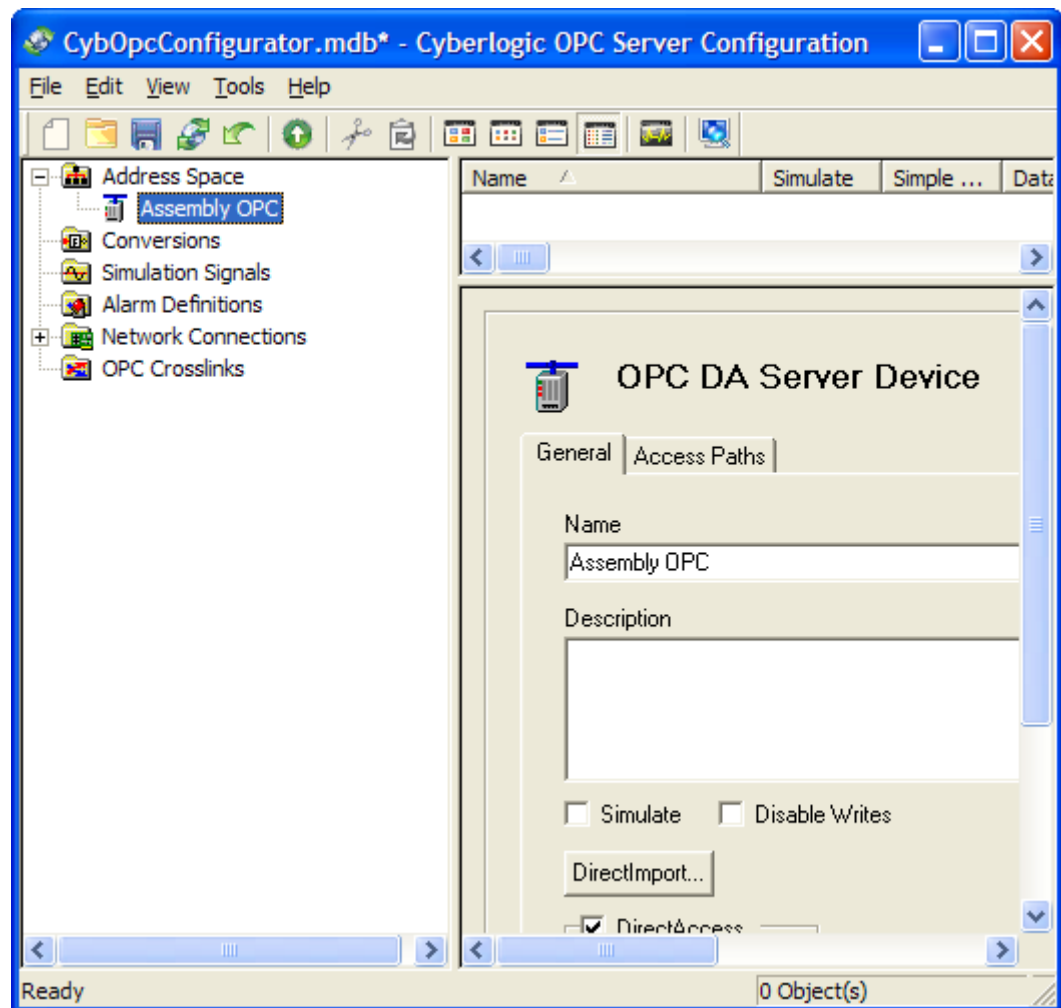

You begin by selecting the device whose configuration you want to import. Here, we chose the Assembly OPC device.

On its General tab, click the ***DirectImport...*** button.

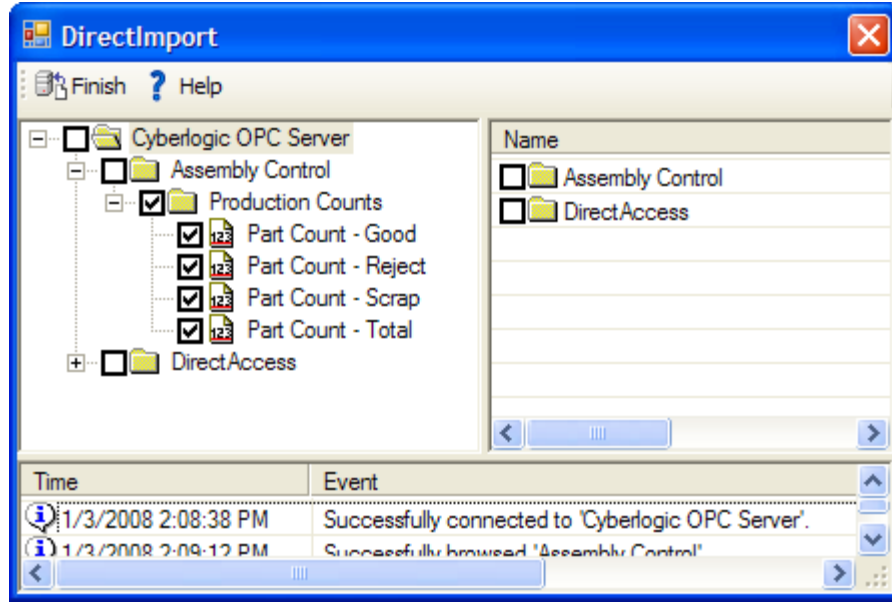

The DirectImport window will open and will show all of the data items in the OPC server you are importing from. You can then expand the branches and select the desired folders and data items by checking them in the left pane.

Checking or unchecking a folder will check or uncheck everything it contains. You may then modify these selections as desired.

Once you've checked all of the items you want to import, click **Finish**.

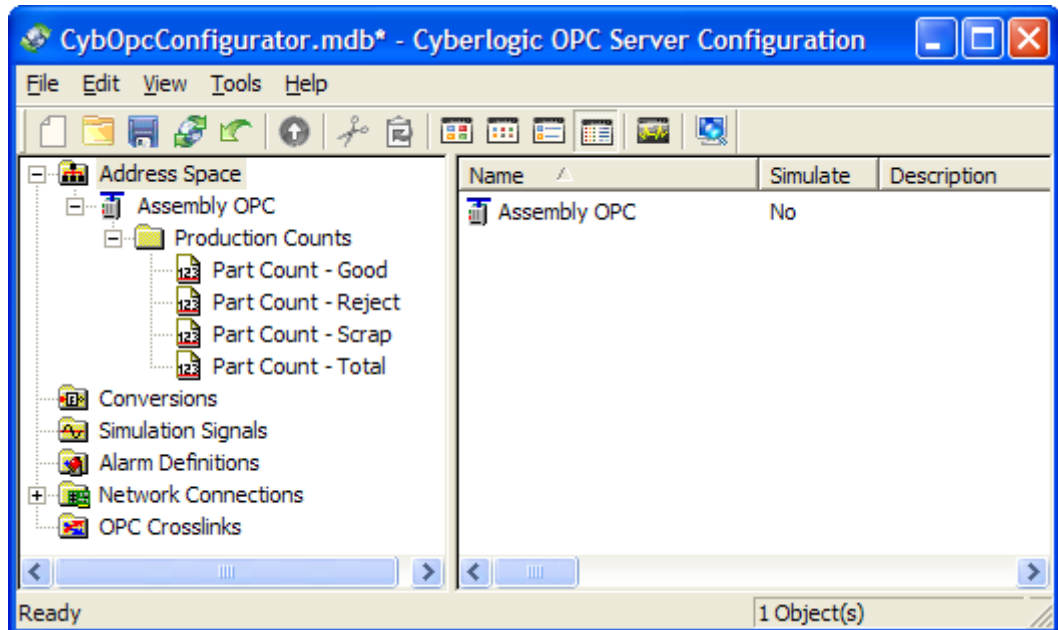

The selected items will be imported into the address space tree.

WHERE CAN I GET MORE INFORMATION?

You can get detailed information on how to install, configure and use the OPC DA Driver Agent by referring to the help files for the OPC Crosslink Suite, DHX OPC Premier Suite or MBX OPC Premier Suite.

Cyberlogic's website, www.cyberlogic.com, has information on related products, news, software downloads and contact information.

Cyberlogic Technologies
5480 Corporate Drive
Suite 220
Troy, Michigan 48098 USA

Sales: 248-631-2200
sales@cyberlogic.com

Technical Support: 248-631-2288
techsupport@cyberlogic.com